

GS/L PRO 30S4 1150X685

Heavy loads hand pallet truck (3.000 kg)



LIFTER GS PRO 30

Extremely tough and resistant hand pallet truck for heavy duty applications, with lifting capacity up to 3.000 kg.

REINFORCED STRUCTURE

Steel bars welded under the forks, solid tie-rod as well as a base with thick metal sheet allow the GS 30 to easily handle the heaviest loads.

HYDRAULIC UNIT

Resistant and reliable one piece cast iron pump, worked with numerical control machine, including:

- **MAXIMUM PRESSURE VALVE:** safety device that ensures the transpallet against overloads. When the pressure inside the hydraulic circuit exceeds the set calibration value according to the maximum nominal flow, the valve automatically locks the forks.
- **PROPORTIONAL LOWERING VALVE:** lowering speed can be proportionally controlled according to the lever position on the tiller. Perfect working tool to carry fragile and delicate loads like crystal, glass and ceramics.

VARNISHING

Following an appropriate conditioning operation the frame is varnished with polyester powder at a temperature of 250° to guarantee maximum resistance to wear and atmospheric agents.



STANDARD CONFIGURATION

- Nylon - Poly 55 steering wheels
- Nylon rollers
- 4 Curves handle with all the controls (lowering / drive position / lifting) available in a single lever for simple and safe control



- Entry/exit rollers. Supplementary rollers to allow easier entrance and quicker exit from a closed pallet, reducing the impact on the main rollers and guaranteeing a longer life.



OPTIONAL CONFIGURATION

- Nylon steering wheels
- Aluminium - Poly steering wheels
- Aluminium - Rubber steering wheels



- Polyurethane rollers



- 4 Curves ergonomic handle. The soft rubber covering aids operator comfort and helps to reduce vibration, enabling a more comfortable and secure grip.



- Manual control brake. The brake of the pallet truck, available with rubber steering wheels, is adjustable through the tiller lever to ensure safe use on slopes and ramps. The locking function makes it possible to park the pallet truck even on slopes without rolling away.



- Quick lift. The perfect tool to lift quicker your loads up to 150 kg. The hydraulic pump is specifically engineered to cut job time and increase efficiency. It takes just 6 strokes to raise a pallet to full height, instead of 13 with the traditional HPT.



Descriere

1.1 Producător			LIFTER
1.3 Comandă			Manual
1.4 Poziție operare			Pedestru
1.5 Capacitate maximă	Q	Kg	3000
1.6 Distanța la centrul de aplicare al sarcinii	c	mm	600
1.8 Sarcina de la osie la capătul furcilor	x	mm	932
1.9 Ampatament	y	mm	1192

Greutăți

2.1 Greutate de operare		Kg	93
2.2 Sarcină osie, încărcare pe spate		Kg	2198
2.2 Sarcină osie, încărcare pe față		Kg	895
2.3 Sarcină osie, liber spate		Kg	31
2.3 Sarcină osie, liber față		Kg	62

Cauciucuri/Șasiuri

3.1 Cauciucuri: roți direcție			POLY.I./ NYLON
3.1 Cauciucuri: transportoare cu role			NYLON
3.2 Mărime cauciuc: roți direcție - Diametru		mm	200
3.2 Mărime cauciuc: roți direcție - Lățime		mm	55
3.3 Mărime cauciuc: transportoare cu role - Diametru		mm	82
3.3 Mărime cauciuc: transportoare cu role - Lățime		mm	60
3.5 Dimensiune cauciuc: roți spate		nr	4
3.5 Ax de echilibru spate			No
3.6 Ecartament, față	b10	mm	155
3.7 Ecartament, spate	b11	mm	535

Dimensiuni

4.4 Înălțime stivuitor	h3	mm	115
4.9 Înălțime manetă în poziția de deplasare, max	h14	mm	1160
4.15 Înălțime, coborât	h13	mm	85
4.19 Lungime globală	l1	mm	1550
4.20 Distanța până la suprafața frontală a furcilor	l2	mm	400
4.21 Lățime globală	b1	mm	685
4.22 Dimensiuni furcă - grosime	s	mm	50
4.22 Dimensiuni furcă - Lățime	e	mm	150
4.22 Dimensiuni furcă - Lungime	l	mm	1150
4.25 Distanța între furci	b5	mm	685
4.32 Gardă la sol și mijloc ampatament	m2	mm	35
4.34 Lățime culoar	Ast	mm	1835
4.35 Rază de virare	Wa	mm	1367

Performante

5.2 Viteză de ridicare, încărcat	strokes	13
5.2 Viteză de ridicare, descărcat	strokes	13

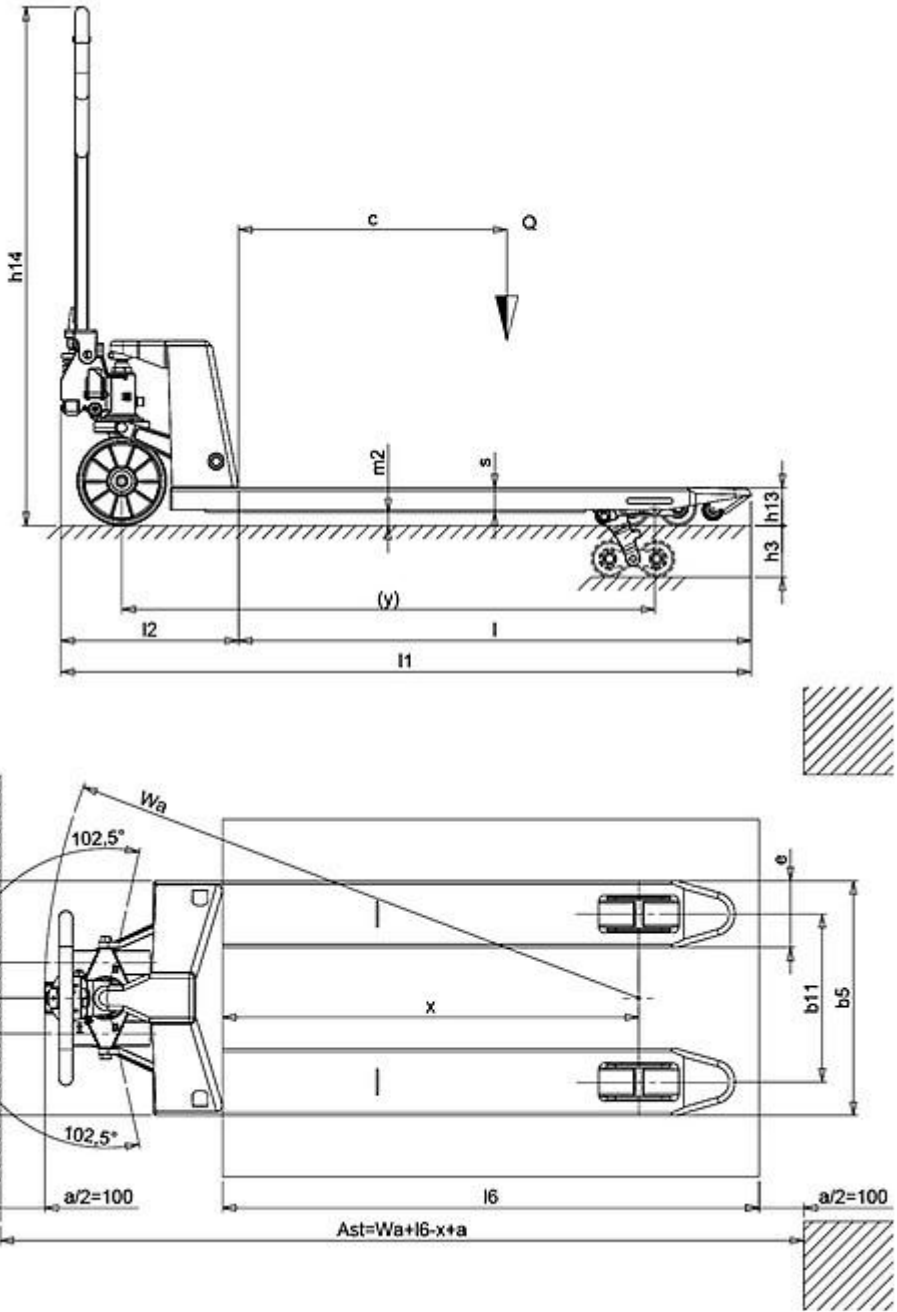

The information is aligned with the Data file at the time of download. Printed on 23/02/2020 (ID 577)

©2019 | PR INDUSTRIAL s.r.l. | All rights reserved | Image shown may not reflect actual package. Specifications subject to change without notice

